



Production Industries Inc.
A Frost Inc. Company

**Engineered Class Conveyor Chain
and Component Solutions**



Engineered Class Chain Expert

Production Industries, a subsidiary of Frost Inc., has been manufacturing heavy-duty standard and custom specialty chains for a variety of material handling applications since 1952. Over the years, we have focused on providing customers with exceptional customer service and dependable products which has made us the preferred Engineered Class Chain provider.

DESIGNED FOR EXTREME ENVIRONMENTS

Our products are engineered and manufactured to exceed expectations in harsh operating environments. They are built by skilled employees using the highest quality materials available which provides the reliability sought after from our customers in the following industries:

- Automotive
- Forestry
- Mining
- Recycling
- Food Processing
- Municipalities / Wastewater Treatment
- Paper Mill
- Refineries

UNMATCHED SERVICE

Regardless of the size and scope of your project, our experienced Sales and Engineering staff can recommend the best chain solution for your operation and budget. If your chain still has remaining life, we can also provide specialty conveyor components for your replacement needs. From chains, to sprockets, wheels and other accessories, we have everything you need for your Conveyor Systems.

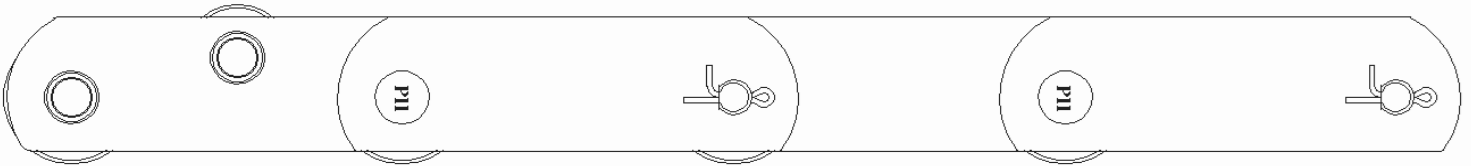

FAMILY OF CONVEYANCE

Production Industries is part of the Frost family of businesses which provides a wide variety of conveyor solutions and components for all types of Overhead, Enclosed Track and Ground-Based applications.



PRODUCTION INDUSTRIES™

3535 Rennie School Road
Traverse City, MI 49685
prodind.com
sales@prodind.com
800.791.1409

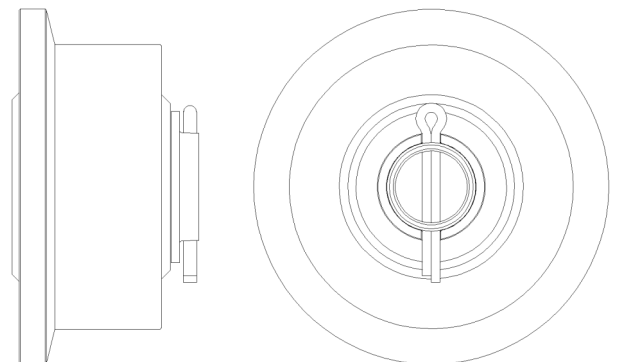

Products Manufactured to Last

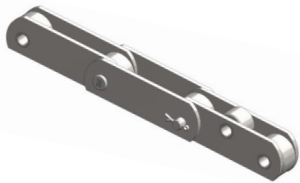

CC-5 A/B

- **Attachments:** Side guides, top plates, raised rollers and welded attachments
- **Rollers:** Steel, UHMW or combination
- **Chain pitch length:** 6" with high sidebar
- **Standard applications:** Automotive, Glass Manufacturing and Large Castings

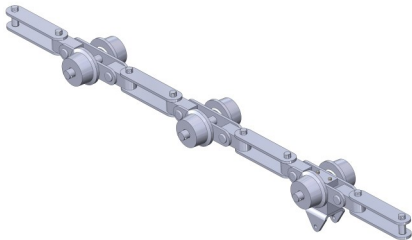

Food Grade

- **Attachments:** Various attachment styles and dogs
- **Rollers:** Steel, nylon, or UHMW
- **Styles:** Stainless, knuckle, offset and straight link
- **Finishes:** Stainless Steel or FDA approved zinc
- **Standard applications:** Beef and Pork Processing

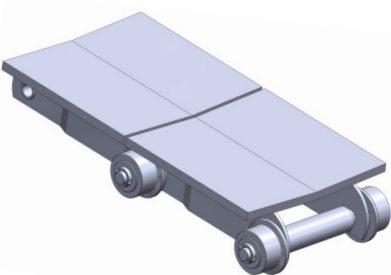

Gull Wing / V-Top

- **Strands:** Single or double
- **Top plates:**
 - Material: Stainless or carbon steel, 3/16" to 5/8" thick, reinforced or not
 - Width: 4" to 24"
 - Finishes: Non-skid, painted, hot dip galvanized, or zinc plated
- **Rollers:**
 - Diameter: 3" to over 6"
 - Style: Flat face, single flange, double flange, Vee
 - Materials: Carbon or various stainless steels, UHMW, Nylon, Urethane, bronze or other
 - Bearings: Steel plain bushing, plastic wear bushing, needle bearing or ball bearing
 - Lubrication: all available in lubricated or nonlubricated versions
- **Sidebars:**
 - Material: Mild, high strength, heat treated and stainless steels
 - Links: Offset or straight
 - Attachments: Formed or welded
- **Chain pitch length:** 6" to 24"
- **Standard applications:** Paper Mills, Aluminum Coil Manufacturing and Direct Transfer Conveyors

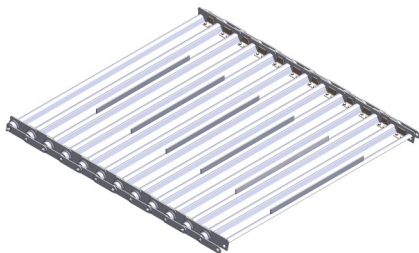

Apron Chain Conveyor

- **Chain width:** 6" to over 96"
- **Pans:** Custom pan profiles or leak proof pans
- **Bearings:** Rollers with plain bushings, roller or ball bearings
- **Bearing Lubrication:** Lubricated or nonlubricated versions
- **Chain pitch length:** 6" to 18"
- **Standard applications:** Bulk Material Handling



Wheels

- **Diameter:** 1 1/2" to over 8"
- **Material:** Cast, steel, stainless steel, UHMW, bronze and nylon
- **Wheel design:** Ball bearings, needle bearings, plain or wear bushings and tapered roller bearings

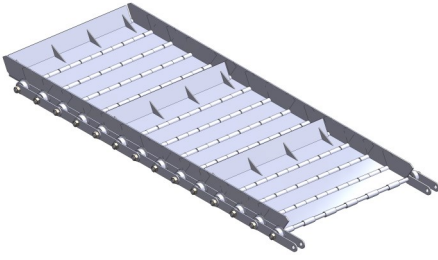

Piano Hinge

- **Chain width:** 6" to over 96"
- **Pans:** Custom pan profiles or leak proof pans
- **Bearings:** Rollers with plain bushings, roller or ball bearings
- **Bearing Lubrication:** Lubricated or nonlubricated versions
- **Chain pitch length:** 6" to 18"
- **Standard applications:** Bulk Material Handling



Water-Screen

- **Material:** Carbon, stainless steel, bronze, or UHMW
- **Specifications:** Made to OEM specifications
- **Side Bar material:** Carbon, stainless steel and bronze
- **Roller material:** Carbon, stainless steel, UHMW
- Replacement parts available for all OEMs
- **Pitch length:** 12" to 24"
- **Standard applications:** Environmental, Waste-water Treatment and Dredging

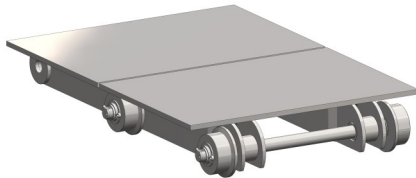

Flat Top

- **Strands:** Single, double, or triple
- **Top plates:**
 - Material: Stainless steel or carbon steel, 3/16" to 5/8" thick, reinforced or not
 - Width: 4" to over 16'
 - Finishes: Non-skid, painted, hot dip galvanized, or zinc plated
 - Wheel cleats or wells available
- **Rollers:**
 - Diameter: 3" to over 6"
 - Style: Flat face, single flange, double flange, Vee
 - Materials: Carbon, various stainless steels, UHMW, Nylon, Urethane, bronze or other
 - Bearings: Steel plain bushing, plastic wear bushing, needle bearing or ball bearing
 - Lubrication: all available in lubricated or nonlubricated versions
- **Sidebars:**
 - Material: Mild, high strength, heat treated and stainless steel
 - Links: Offset or straight
 - Attachments: Formed or welded
- **Chain pitch length:** 2.609" to over 24"
- **Standard applications:** Automotive and Industrial

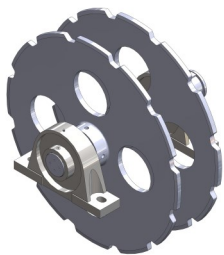

Sprockets, Shafts, Pillow Blocks and Take-Ups

- **Tooth:** Standard, compensator or skip
- **Materials:** Heat treated carbon steel or stainless steel
- **Hub style:** Custom hubs or pitch with bore and keyway
- **Hubs finish:** Plain, bronze bushed, heat treated carbon steel, Stainless steel or keyed

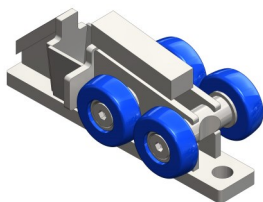

Replacement and Special Parts

We design and manufacture all types of replacement parts for OEMs. If you don't know the OEM we also have the ability to reverse engineer the part.



Production Industries Inc.
A Frost Inc. Company

Traverse City, MI | prodind.com | 800.791.1409